

OPCIÓN RIEL INCLINADO / SLOPING HEADRAIL OPTION
OPTION RAIL INCLINÉ / OPZIONE BINARIO INCLINATO

SUSTITUCIÓN CARRITOS / RUNNERS MAINTENANCE
REPLACEMENT DES CHARIOTS / SOSTITUZIONE CARRELLI

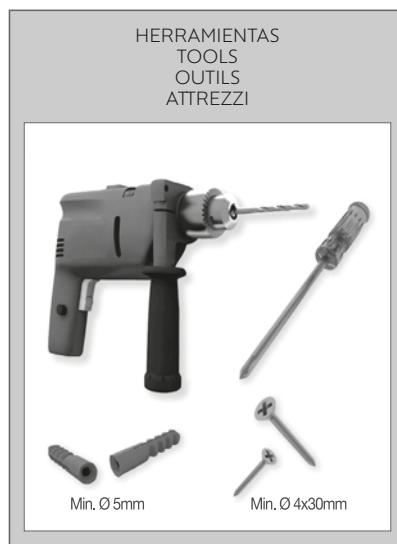
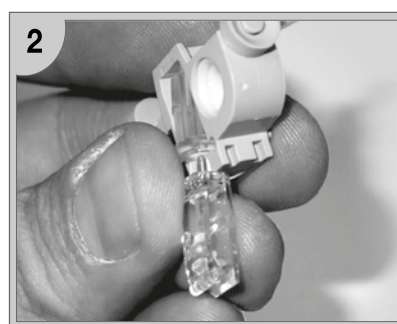
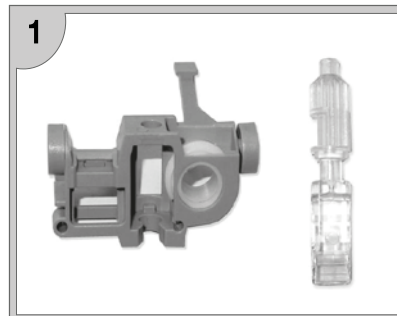
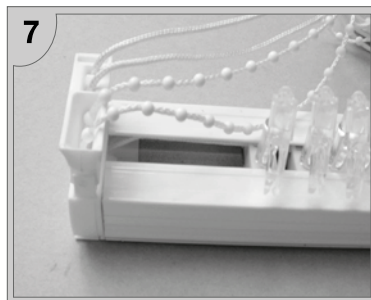
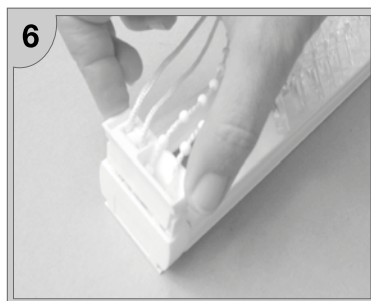
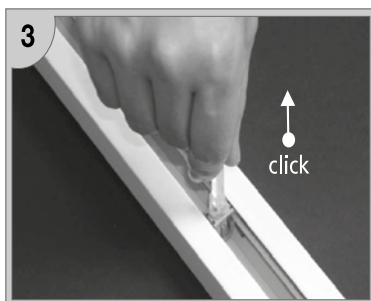
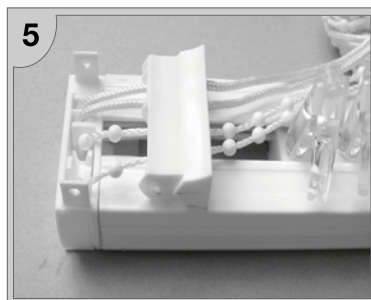
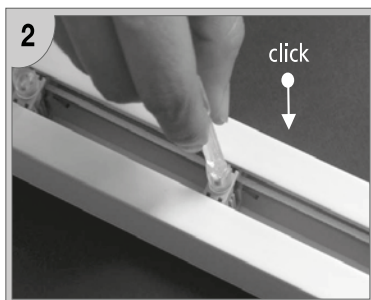
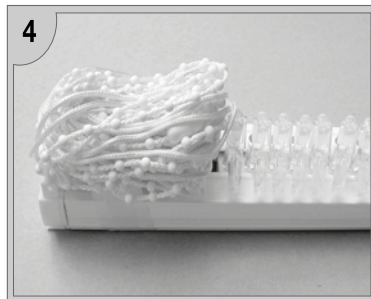
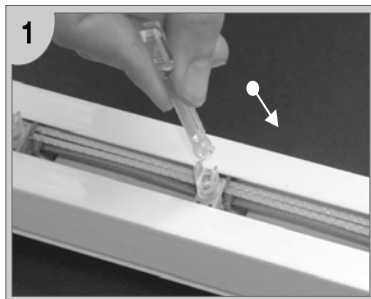

viewt[®]

MASTERS OF BLINDS&SHADES

Instalación - Installation - Montage - Installazione

Cortina vertical
Vertical blind

Store à bandes verticales
Tenda Verticale

A CADENA Y CORDÓN / CHAIN-AND CORD-OPERATED / À CHAÎNETTE ET CORDON / CATENA E CORDA

INSTRUCCIONES DE MONTAJE / ASSEMBLY INSTRUCTIONS / INSTRUCTIONS DE MONTAGE / ISTRUZIONI DI MONTAGGIO

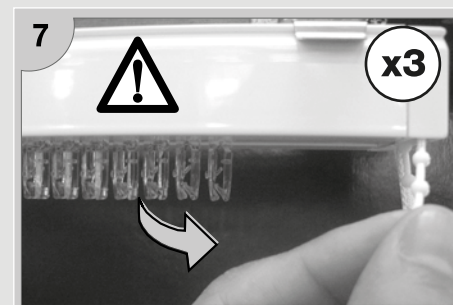
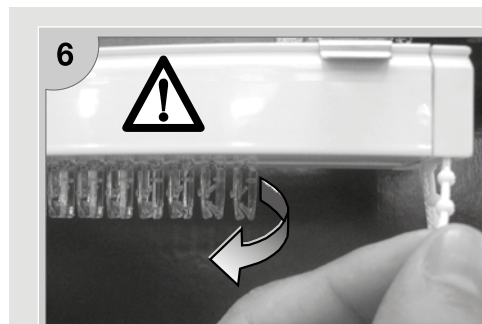
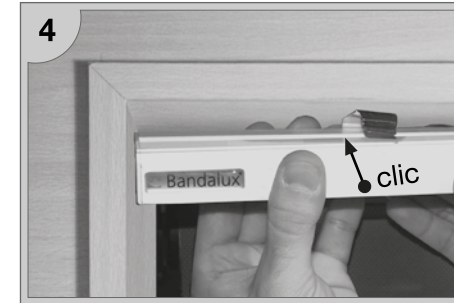
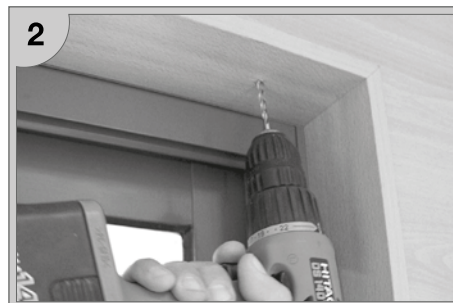
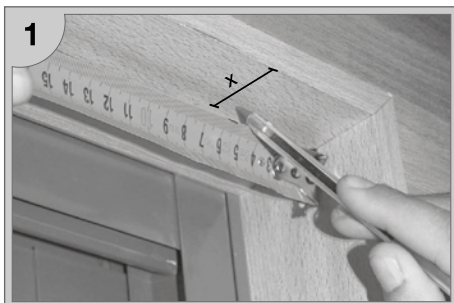

9-10-11-12. No aplica para confección sin cadena distanciadora (contrapeso metálico). / Not available for confection without separator chain (metal counterweight). / Ne s'applique pas pour confection sans chaînette bas de bande (plaquette de lestage métallique). / Non si applica agli confezione senza catena distanziatrice (contrappeso in metallo).

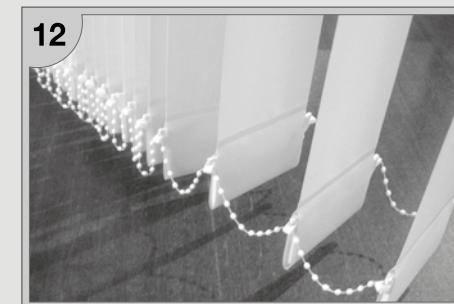
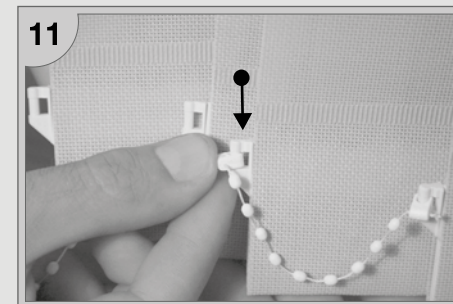
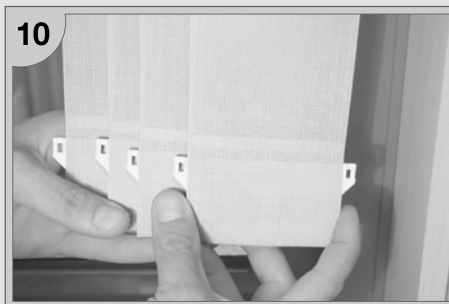
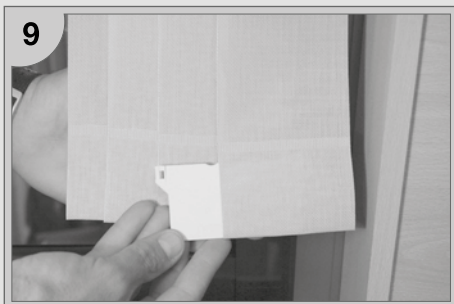

13-14-15. Es necesario el uso del tensor de cordón para garantizar el correcto funcionamiento del sistema. / It is necessary the use of the cord tensor to guarantee the correct functioning of the system. / Il est nécessaire d'utiliser le contrepois de chaînette/cordon pour garantir le bon fonctionnement du système. / È necessario l'uso del fiocco della corda per assicurare il corretto funzionamento del sistema.

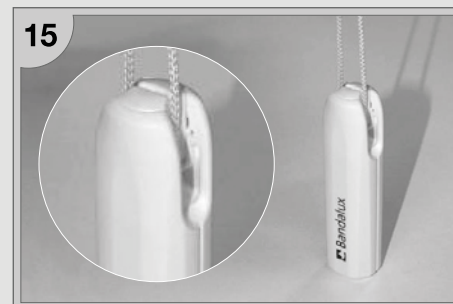
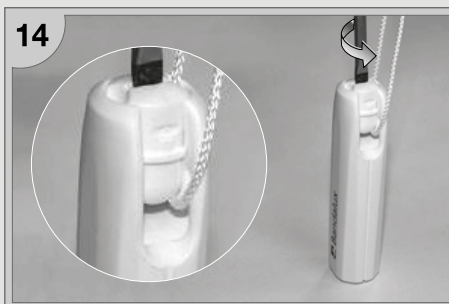

6-7. Para asegurar el **correcto funcionamiento de los carritos**, accione 3 veces la orientación de la cortina sin lamas. No realizar esta operación puede originar problemas de orientación, que no serán motivo de reclamación.

6-7. To ensure **smooth operation of the runners**, please operate the blind 3 times without its slats. If you don't perform that operation, it might cause orientation problems which won't be accepted as claim reason.

6-7. Pour un **fonctionnement correct des chariots**, veuillez actionner 3 fois le store sans ses lames. La non réalisation de cette opération pourrait provoquer quelques problèmes d'orientation qui ne pourront pas être retenus comme motif de réclamation.

6-7. Per assicurare il **corretto funzionamento dei carrellini**, ruotare 3 volte la posizione degli ingranaggi senza le bande. Non realizzare questa operazione può provocare problemi di orientamento, che non saranno motivo di reclamo.